

## SPECIFICATION

- Part No. : **GW.26.0111.HT**
- Product Name : 2.4GHz Miniature Screw Mount Monopole Antenna  
HIGH TEMPERATURE
- Feature : SMA(M) Straight Connector, 50 Ohm  
**Dupont® Hytrel® High Temperature Resistant  
TPEE Housing (up to 150°C)**  
**ROHS Compliant**



## 1 Introduction

The GW.26 HT series 2.4 GHz Monopole SMA (M) mount antenna is ideal for 2.4 GHz wireless applications such as Wifi, Zigbee and Bluetooth.

Antenna housing is made of highly resistant Dupont® Hytrel® TPEE material which is durable in high temperature application environments up to 150°C. This material is often applied in automotive or industrial applications, where the antenna is placed near the engine or heat generating components.

Many module manufacturers specify peak gain limits for any antennas that are to be connected to that module. Those peak gain limits are based on free-space conditions. In practice, the peak gain of an antenna tested in free-space can degrade by at least 1 or 2dBi when put inside a device. So ideally you should go for a slightly higher peak gain antenna than mentioned on the module specification to compensate for this effect, giving you better performance.

Upon testing of any of our antennas with your device and a selection of appropriate layout, integration technique, or cable, Taoglas can make sure any of our antennas' peak gain will be below the peak gain limits. Taoglas can then issue a specification and/or report for the selected antenna in your device that will clearly show it complying with the peak gain limits, so you can be assured you are meeting regulatory requirements for that module.

For example, a module manufacturer may state that the antenna must have less than 2dBi peak gain, but you don't need to select an embedded antenna that has a peak gain of less than 2dBi in free-space. This will give you a less optimized solution. It is better to go for a slightly higher free-space peak gain of 3dBi or more if available. Once that antenna gets integrated into your device, performance will degrade below this 2dBi peak gain due to the effects of GND plane, surrounding components, and device housing. If you want to be absolutely sure, contact Taoglas and we will test. Choosing a Taoglas antenna with a higher peak gain than what is specified by the module manufacturer and enlisting our help will ensure you are getting the best performance possible without exceeding the peak gain limits.

Connection is made via a fixed SMA(M) connector with a hardened TPEE casing, this antenna is the ideal Wi-Fi-Bluetooth-ZigBee antenna for M2M devices where the antenna must be placed in harsh high temperature environments.

## 2 Specification

Wi-Fi 2.4GHz	
Frequency	2400~2500MHz
Bandwidth	100MHz
Peak Gain	1.2dBi
Radiation Efficiency	> 40%
Radiation	Omni-directional
Polarization	Vertical
Power Handling 1W Max	Power Handling 1W Max
Electrical Wave	Monopole
Impedance	50Ω
Operating Temperature	-40°C ~ +150°C
Storage Temperature	-40°C ~ +85°C

### 3 Mechanical Properties

No	Parameter	Specification
1	Temperature	-40°c to +150°c
2	Radome Colour	Black
3	Radome Material	Dupont® Hytrel® TPEE

### 4 Antenna Characteristics

#### 4.1 Antenna S11

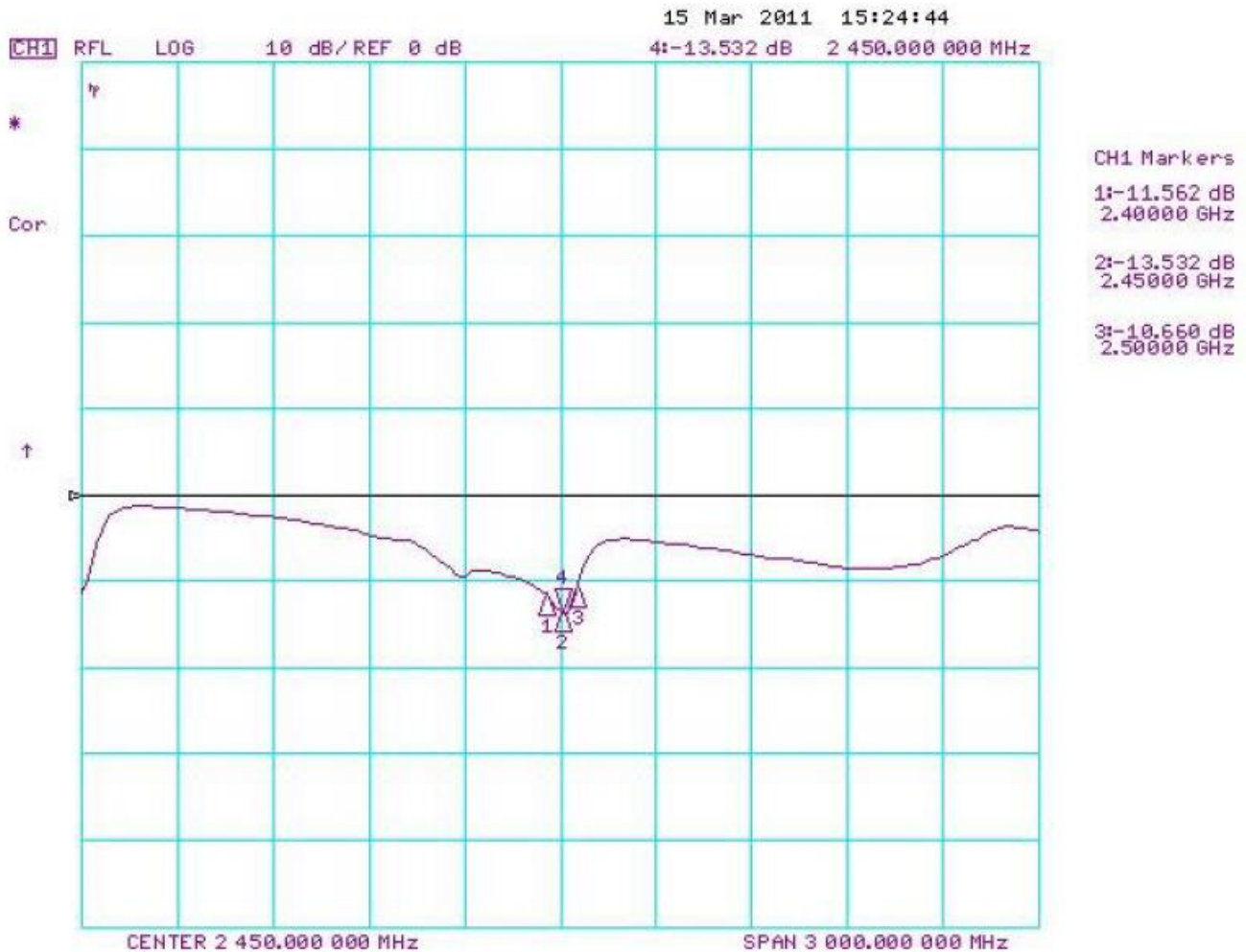

## 4.2 Antenna Peak Gain

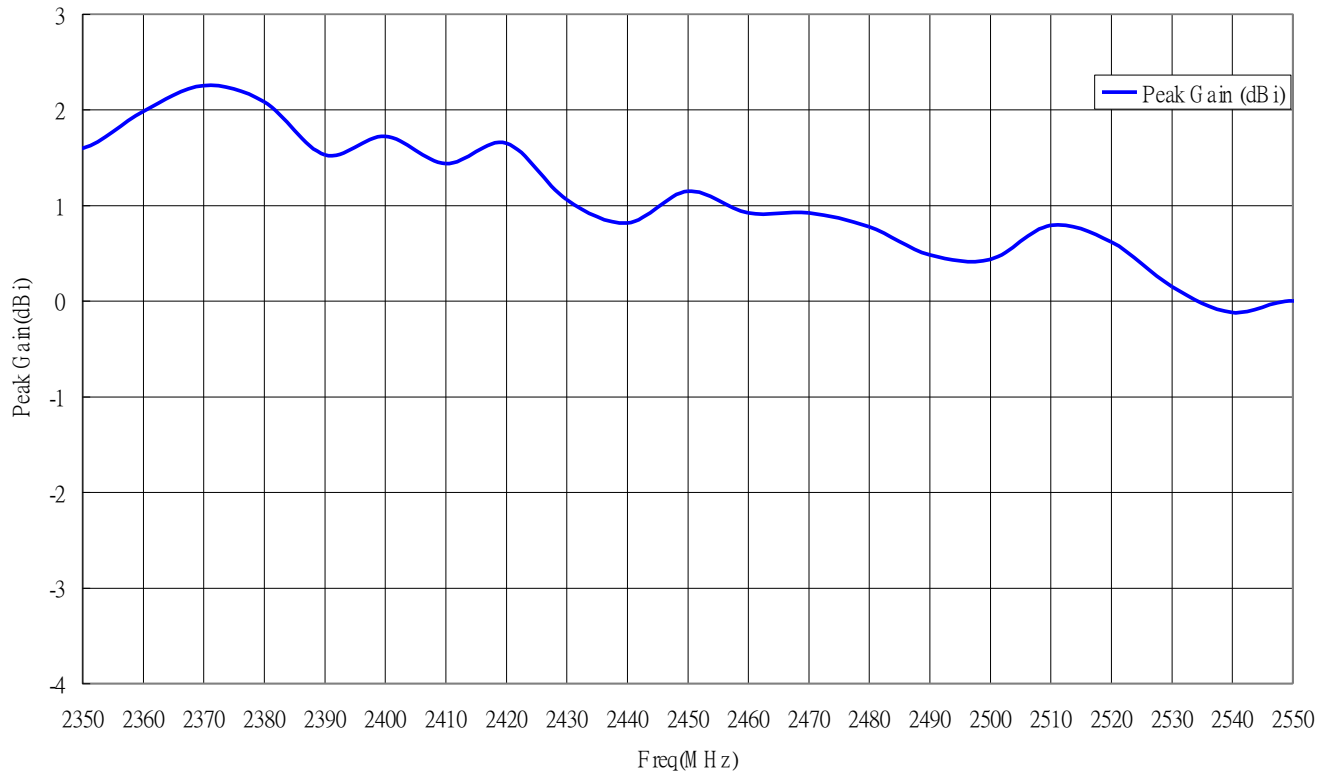

### 4.3 Antenna Efficiency

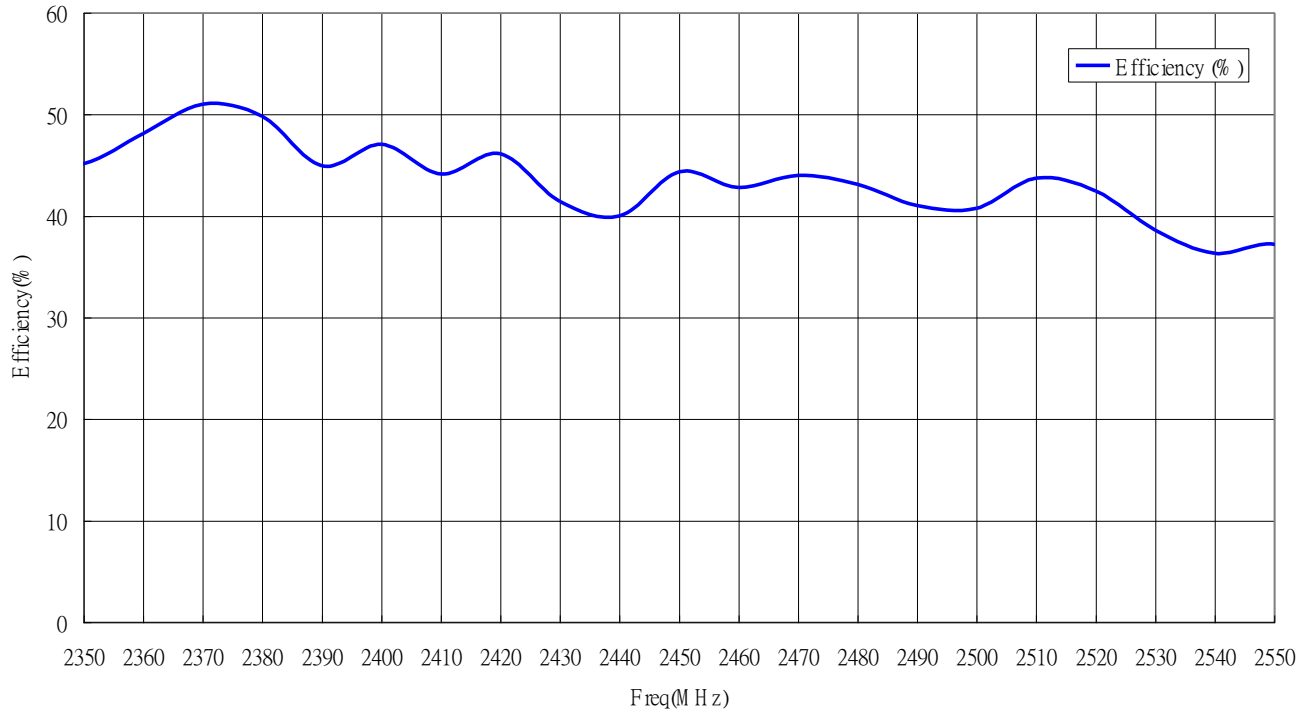

## 4.4 Antenna pattern (XY plane)

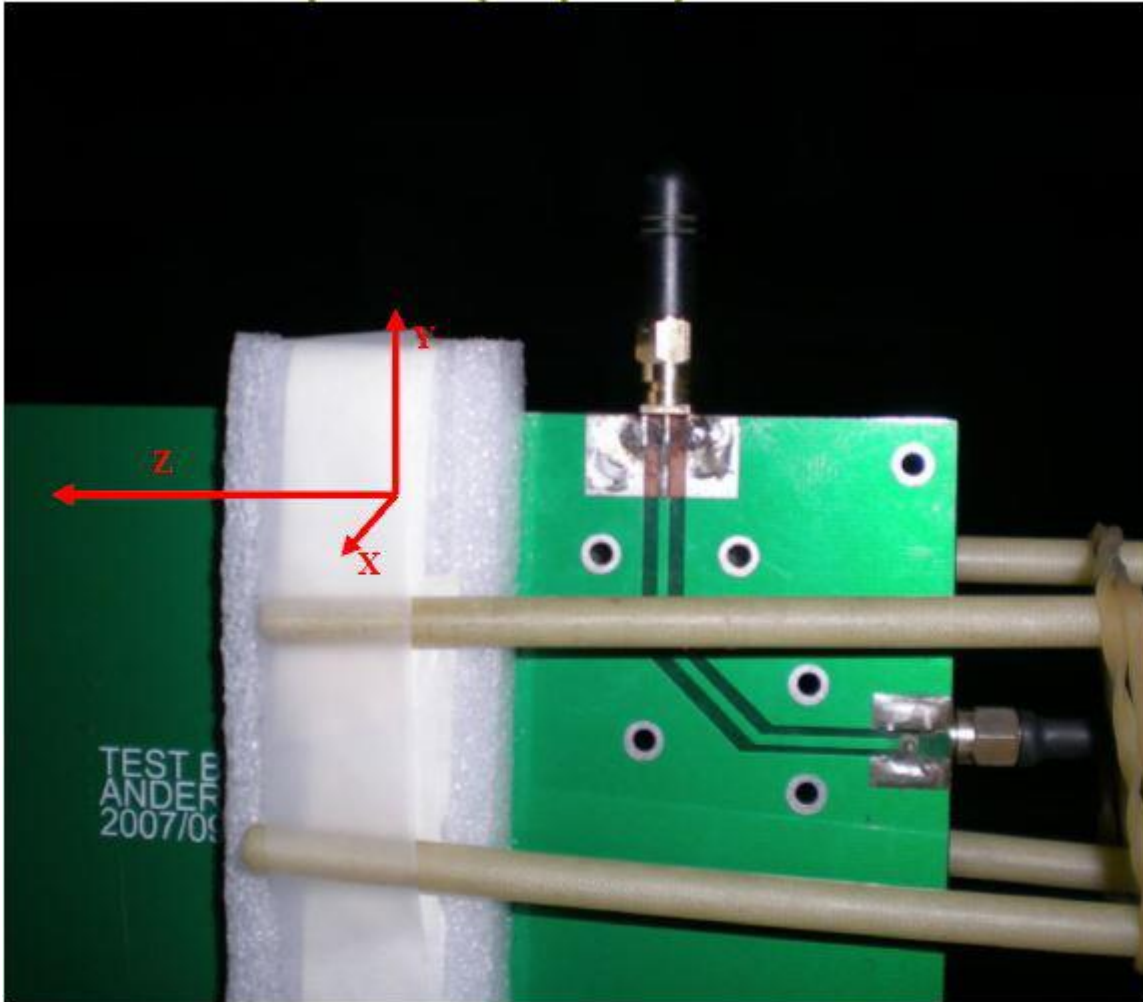

## 4.5 Antenna pattern (XY plane)

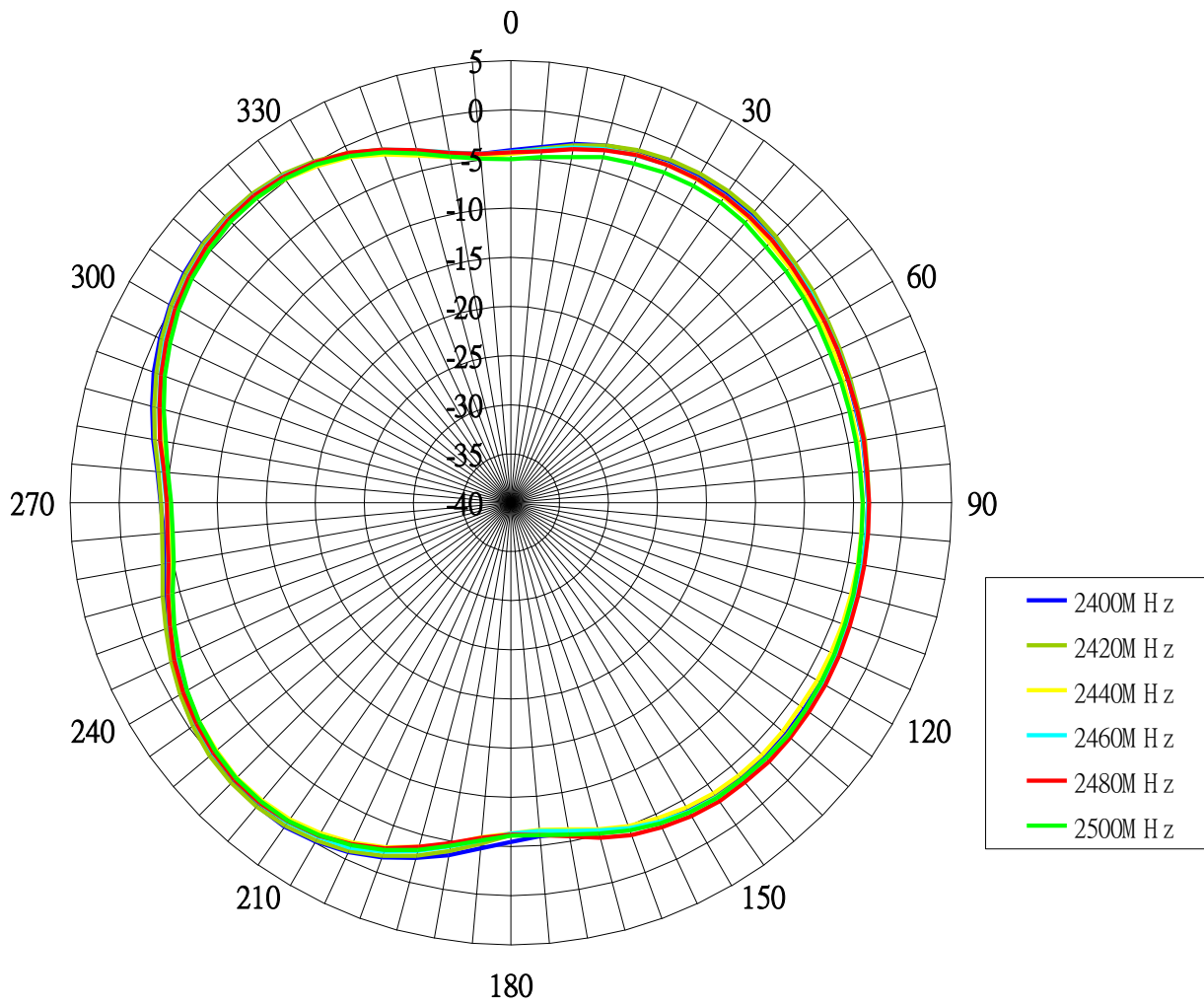



## 4.6 Antenna pattern (XZ plane)

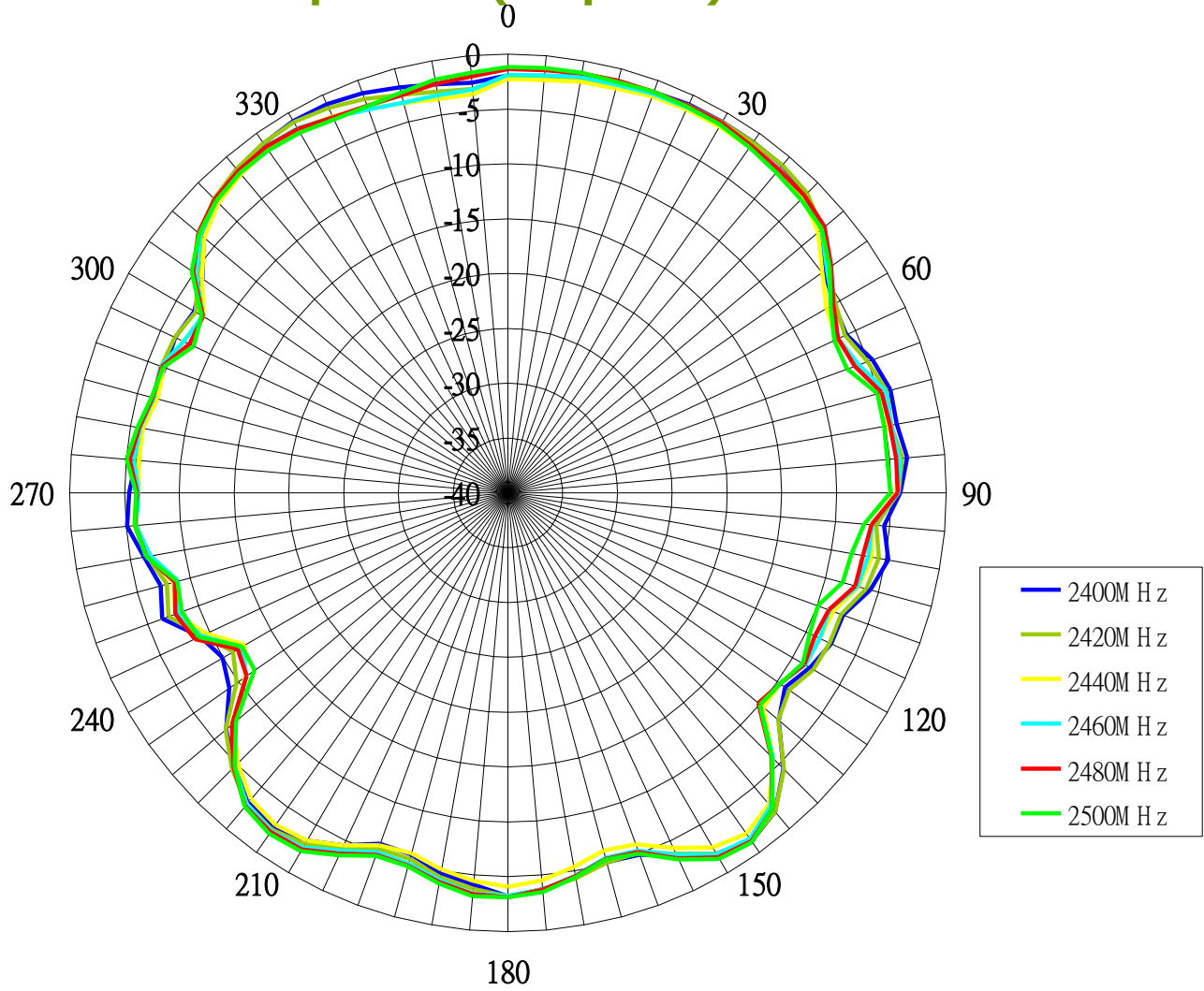

### 4.7 Antenna pattern (YZ plane)

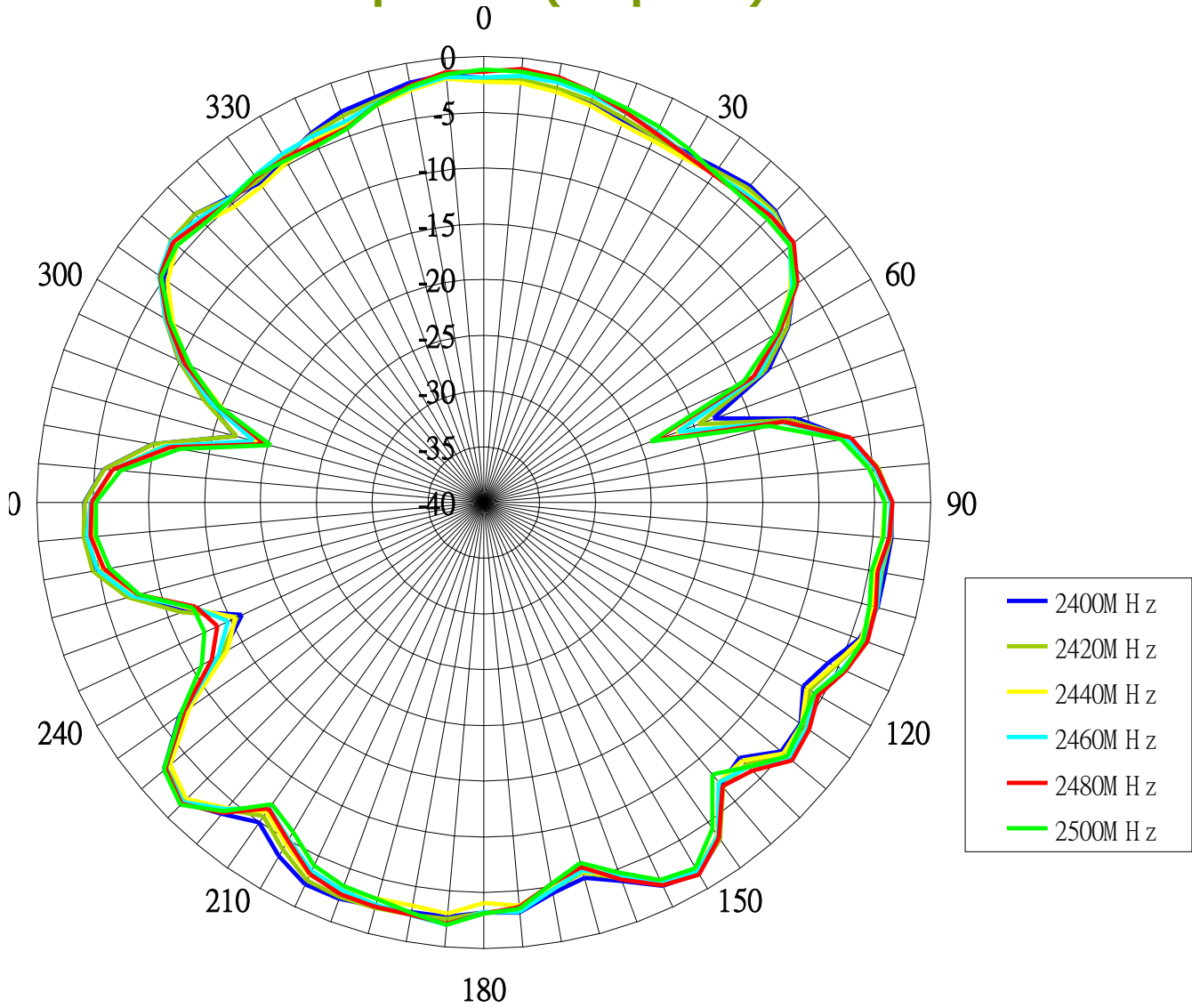

## 5. Outline Drawings and Structure

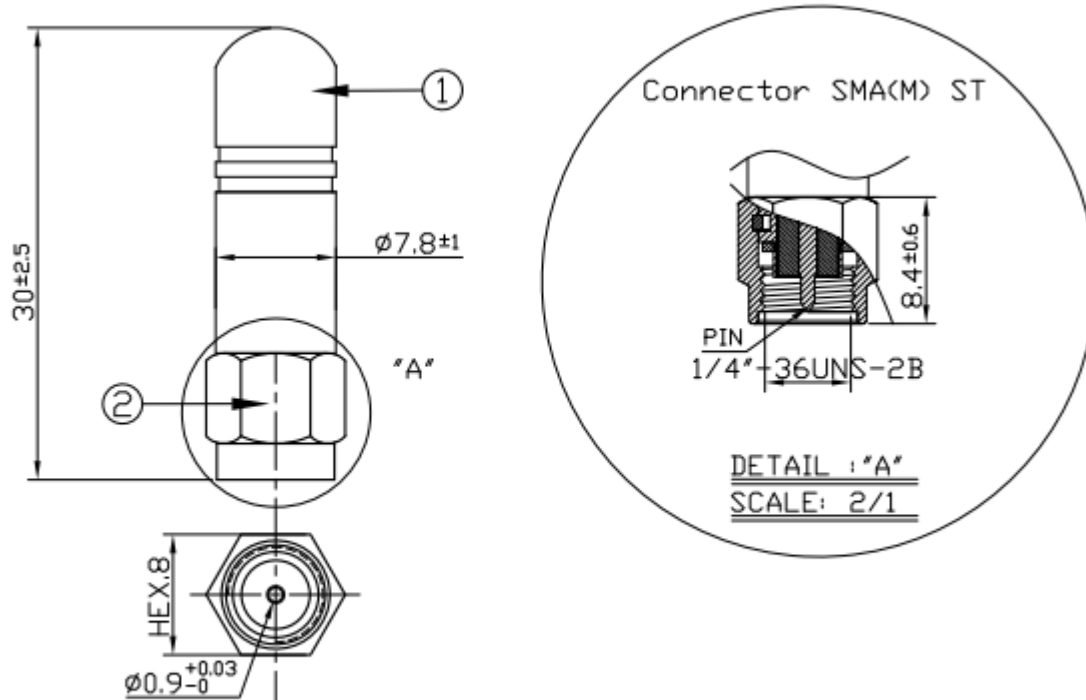

	Name	Material	Finish	QTY
①	GW.26 Housing High Temperature	TPEE	Black	1
②	SMA(M) ST	Brass	Ni Plated	1