

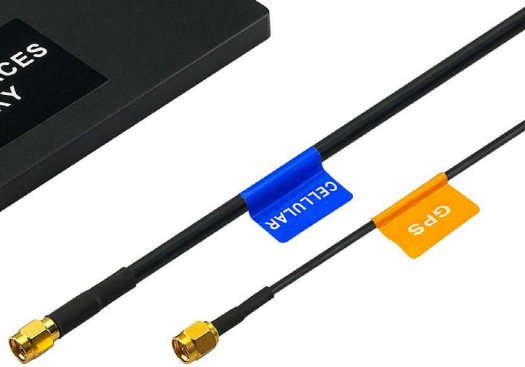

Topside View



Underside View

Stream

MA208.A.AB.001

Specification

Part No.	MA208.A.AB.001
Product Name	Stream GPS and LTE/GSM/UMTS [2G/3G/4G 700MHz to 960MHz/1710MHz to 2200MHz] Combination Antenna
Feature	Adhesive Mount IP67 Antenna GPS: 3M RG-174 SMA(M) Cellular: 3M CFD-200 SMA(M) 1.8~5.5V/30dB 200.5*66.5*9mm RoHS Compliant

1. Introduction

The Stream MA.208 GPS/LTE Cellular antenna is a low profile, heavy-duty, fully IP67 waterproof external M2M antenna for use by RF professionals in telematics, transportation and remote monitoring applications. The Stream is unique in the market as it combines the highest possible efficiency and peak gain for GPS and all cellular bands in 2G/3G/4G in a low profile compact format for mounting via high quality first tier automotive approved 3M adhesive foam.

The patent pending design incorporates internally a custom Taoglas 35mm patch antenna on an extended integral ground-plane to deliver more than 3.5dBiC gain. A front-end SAW filter dramatically reduces radiated spurious emissions.

The extended ground-plane used with an innovative internal cellular PIFA also enables the unique wide-band 2G/3G/4G response to deliver the highest performance possible, at 3 metres cable length. Nothing else out there comes close in terms of consistency of efficiency and peak gain at all cellular bands, with an awesome 70%+ at the LTE 700MHz band, again including 3 metres of cable loss. High antenna efficiencies are absolutely critical in today's 3G and 4G systems to achieving targeted data-speeds and coverage.

All this is done while still maintaining 20dB isolation between antennas. The Stream uses high-shielded PTFE dielectric ultra low-loss cables that maintain low attenuation at all frequency bands, and high noise rejection, with an average loss of only 0.3dB per meter

(0.1dB per foot), compared to 0.7dB for RG58 and 1.2dB for RG174.

Because of this, the Stream maximizes chances of passing PTCRB and network approvals first time. The Stream works best when attached to plastic or glass, but can also be used on metal if some foam spacing is added. The Stream comes packaged with a separate 3M first tier automotive approved adhesive which can be attached to either the bottom of the top of the product, for easy mounting directly on glass, or on plastic.

The Stream comes packaged with a separate 3M first tier automotive approved adhesive which can be attached to either the bottom of the top of the product, for easy mounting directly on glass, or on plastic.

2. System Configuration

This antenna specification covers the LTE/GSM/UMTS Full band for 700MHz~960MHz, 1710MHz~2170MHz and GPS (L1 Band).

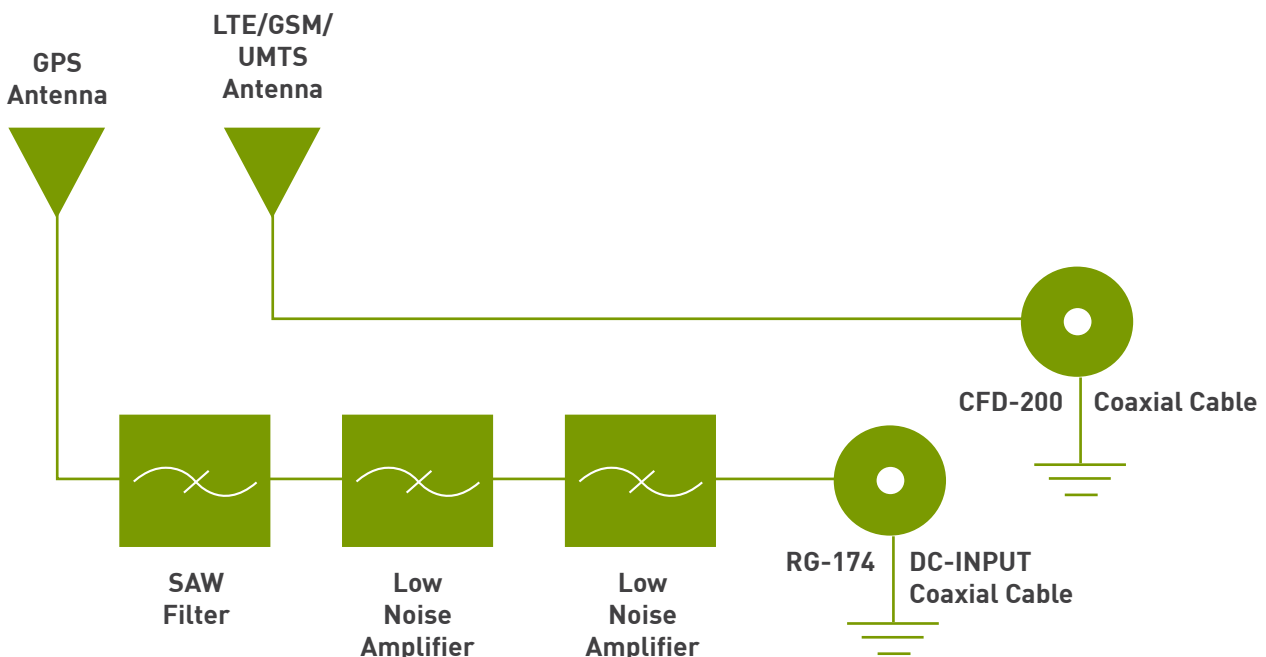

3. Specification

3.1 Electrical Data

Parameter	GPS Antenna	Cellular Antenna
Features	High performance GPS 35*35*4mm ceramic patch antenna with two stage high gain 1575.42 +/- 1.023MHz	LTE - 700MHz CDMA:824~896MHz GSM:880~960MHz DCS:1710~1880MHz PCS:1850~1990MHz 3G:1920~2170MHz
Gain	3.5dBic typ @ Zenith	Average:-3.03dBi at 700~960MHz -4.34dBi at 1710~2170MHz Peak: 2.16dBi at 700~960MHz 0.42dBi at 1710~2170MHz
Polarization	RHCP	Linear
VSWR		3.3 Max. at 700~960MHz 3.6 Max. at 1710~1850MHz 2.2 Max. at 1880~2170MHz
Impedance	50Ω	50Ω
Efficiency		≥ 68% @ 700MHz ≥ 72% @ 750MHz ≥ 66% @ 824MHz ≥ 56% @ 890MHz ≥ 61% @ 880MHz ≥ 53% @ 960MHz ≥ 37% @1710MHz ≥ 51% @1880MHz ≥ 55% @1990MHz ≥ 54% @2110MHz ≥ 45% @2170MHz

3.2 Cable and Connectors (Fully Customisable)

Parameter	GPS Antenna	Cellular Antenna
Cable	3M RG-174	CFD-200
Connector	SMA(M)	SMA(M)

3.3 Mechanical Data

Parameter	
Housing	UV resistant PVC
Adhesive Mount	- 3M 1600SB(197.5*63.5*1.2mm)
Protection Class	IP-67
Operation Temperature	-40°C to +85°C
Storage Temperature	-40°C to +85°C
Relative Humidity	20% to 95%
Weight per unit	0.18kg

*Note: specifications may be subject to change

4. Axial Ratio

4.1 With IPEX Cable

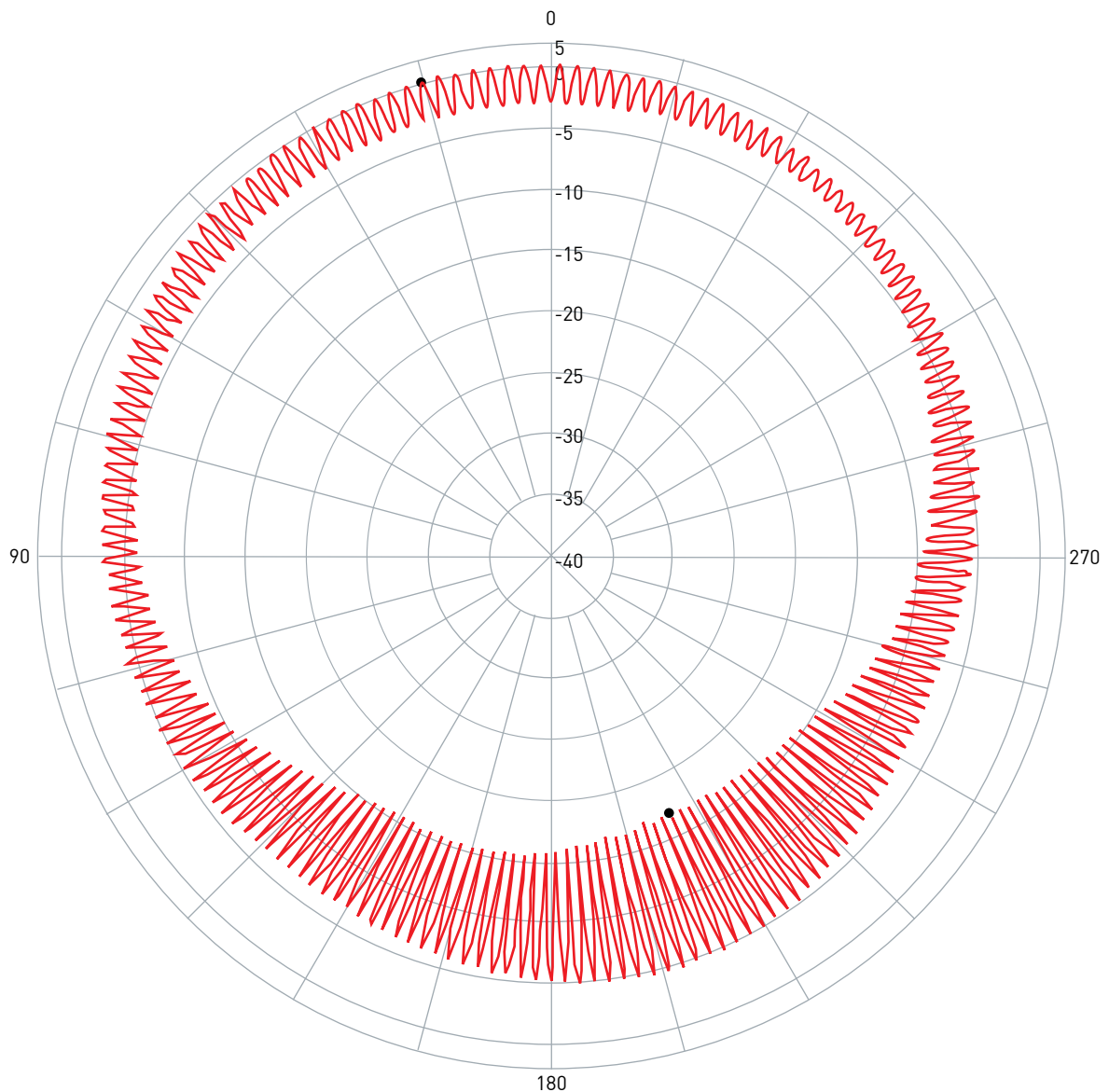

Pattern	Model No.	Test Mode	Freq (MHz)	Max Gain(dBi)	Min Gain(dBi)	Avg. Gain(dBi)	Source Polar.
1	MA208.A.AB.001	Axial Ratio	1575.42	0.06 / 15.14	-16.87 / 204.77	-4.51	CP

4. Axial Ratio

4.2 3M CFD-200 Cable

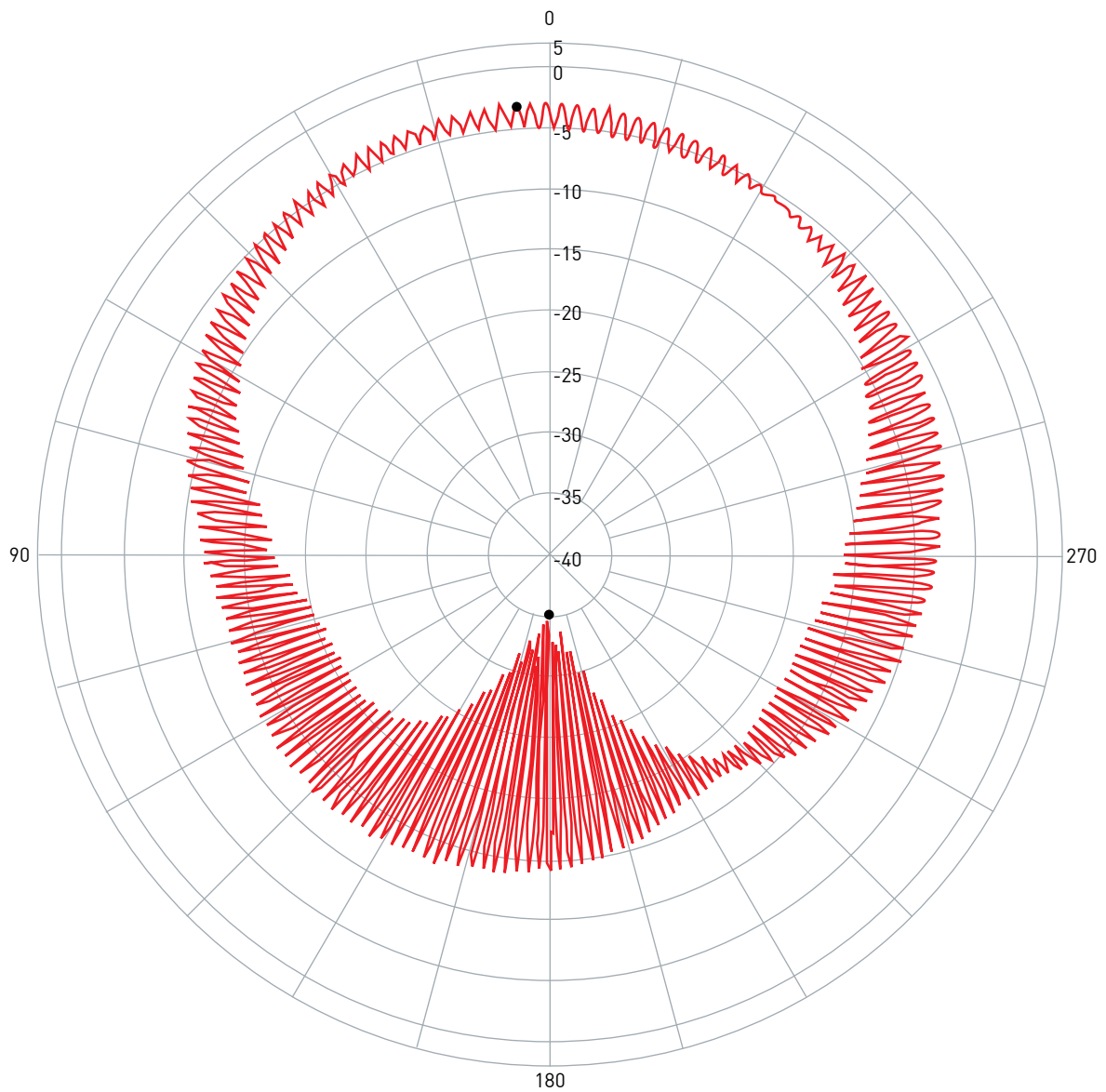

Pattern	Model No.	Test Mode	Freq (MHz)	Max Gain(dBi)	Min Gain(dBi)	Avg. Gain(dBi)	Source Polar.
1	MA208.A.AB.001	Axial Ratio	1575.42	-3.19 / 4.61	-34.89 / 178.75	-8.79	CP

5. Radiation Patterns

5.1 Radiation Pattern in XZ plane

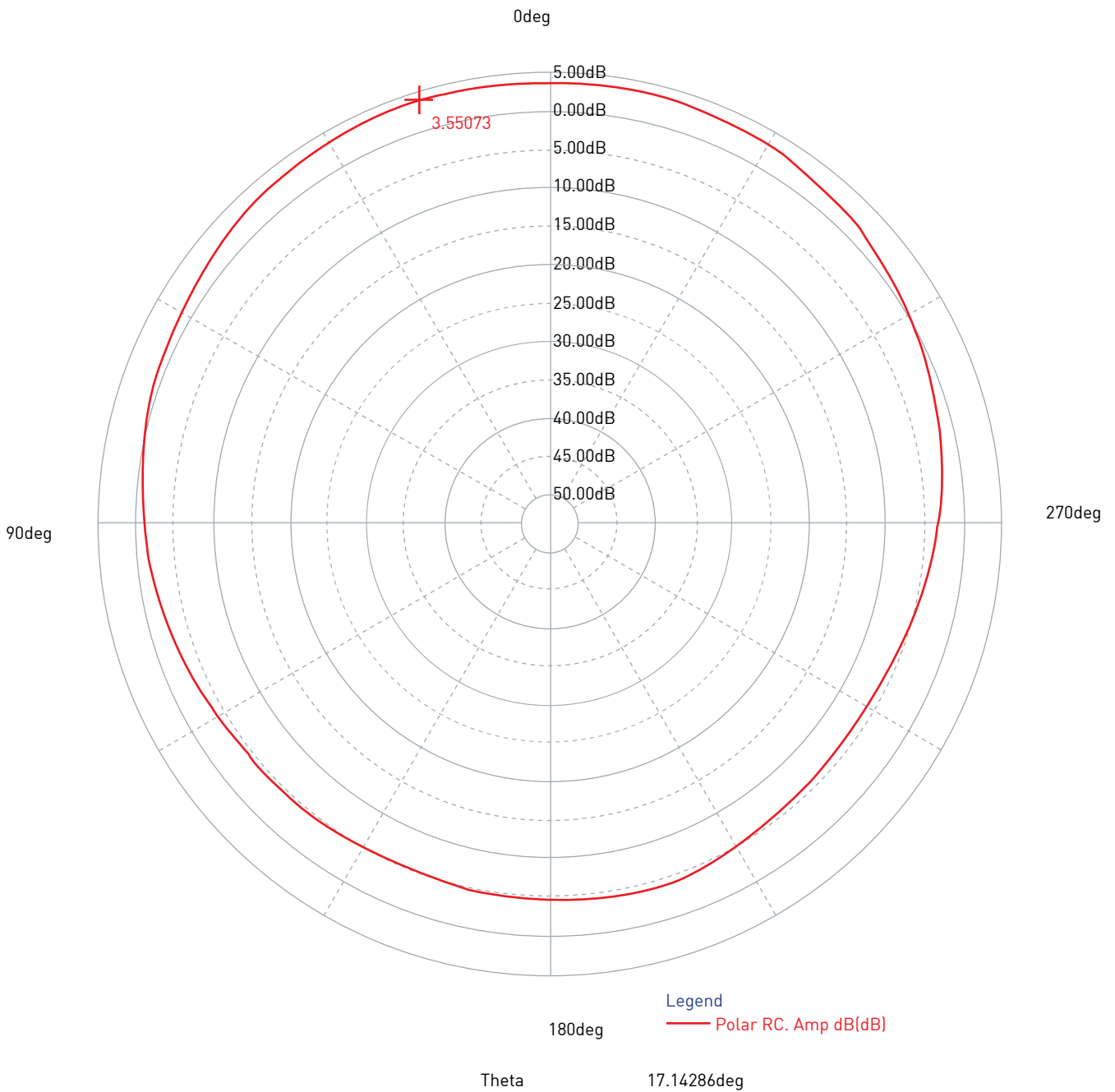

5. Radiation Patterns

5.2 Radiation Pattern in YZ plane

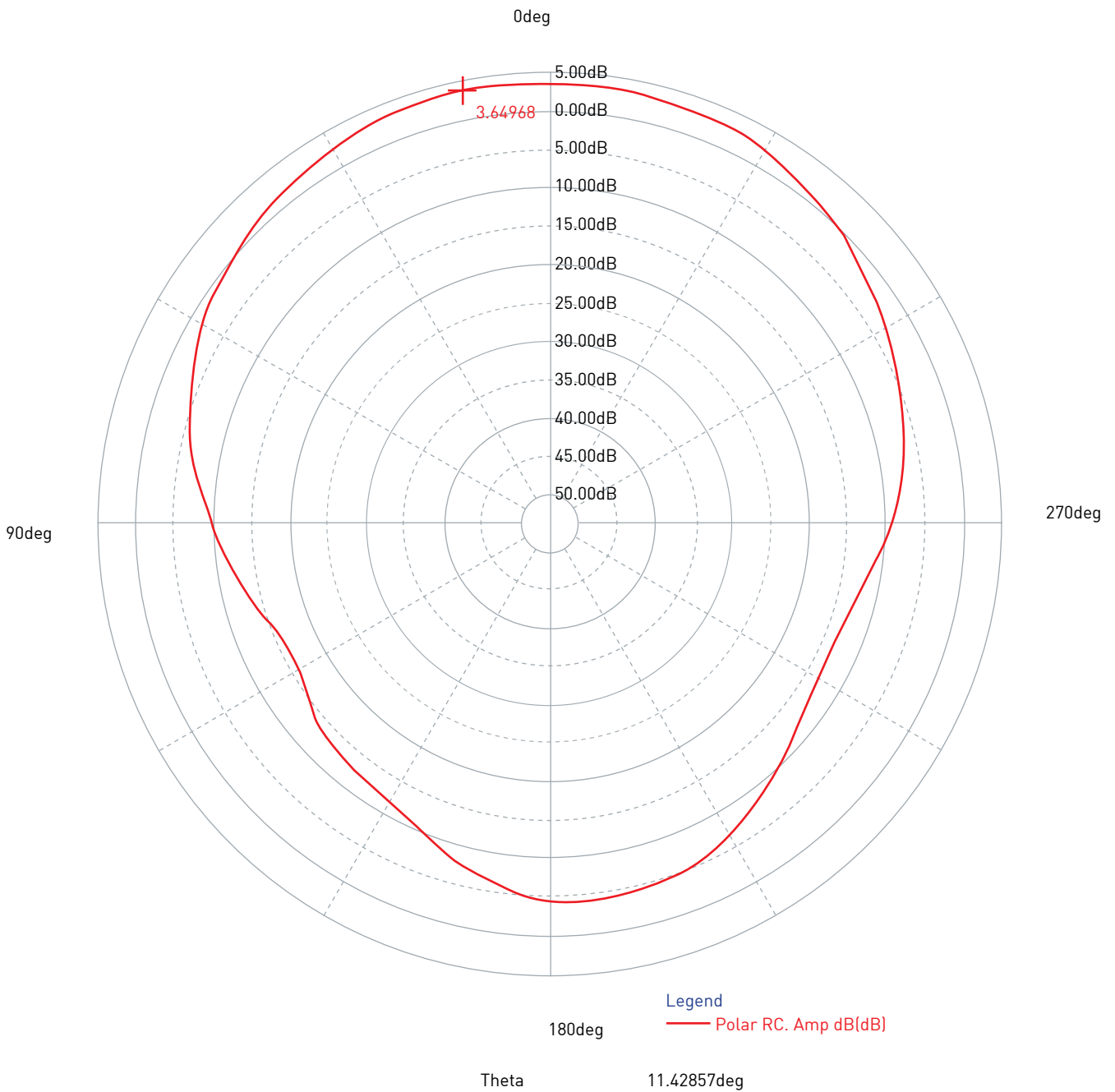

5. Radiation Patterns

5.3 Radiation Pattern in XY plane

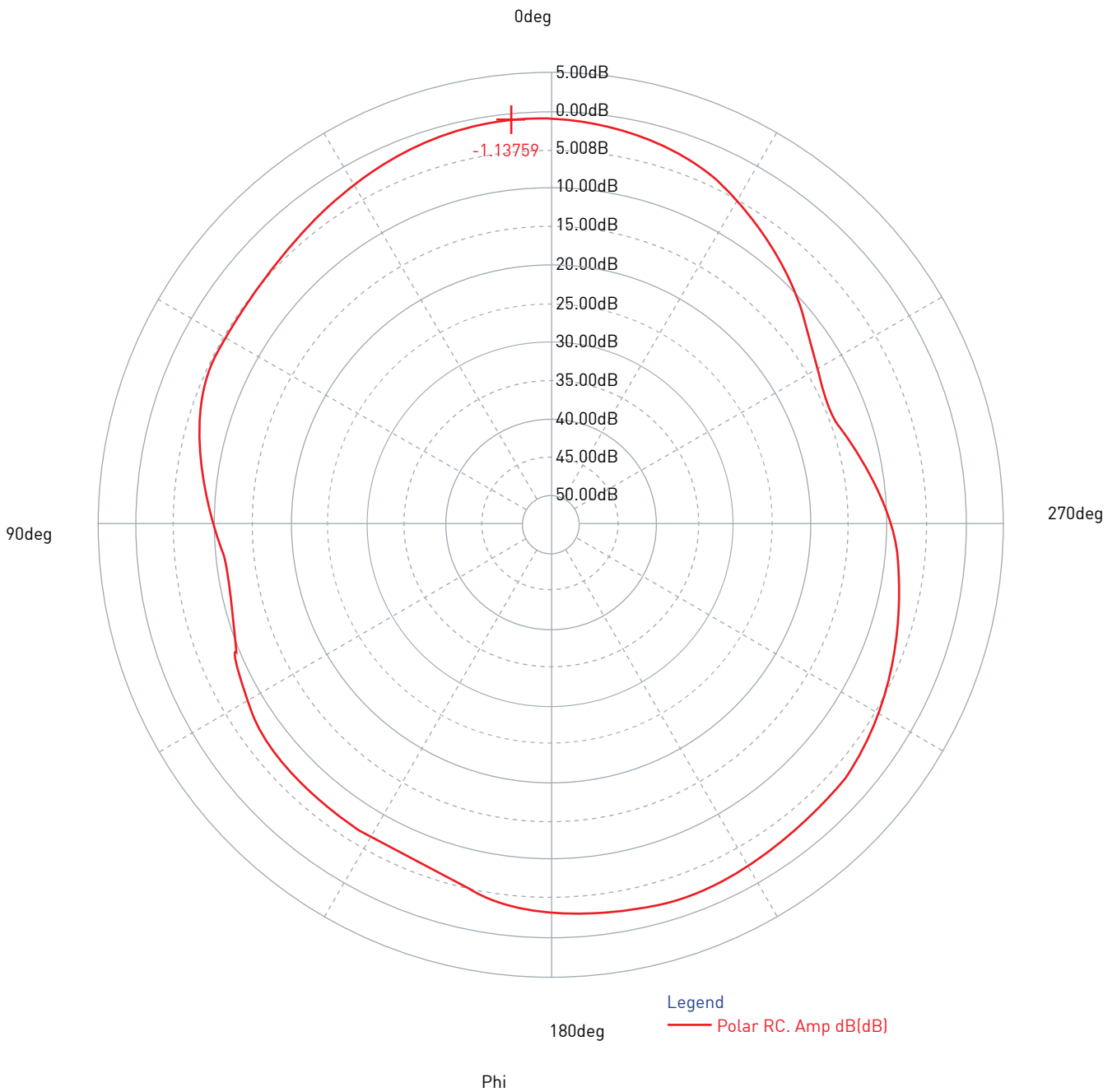

6. VSWR

▶ Tr1 S11 SWR 1.000/ Ref0.000 [F2]

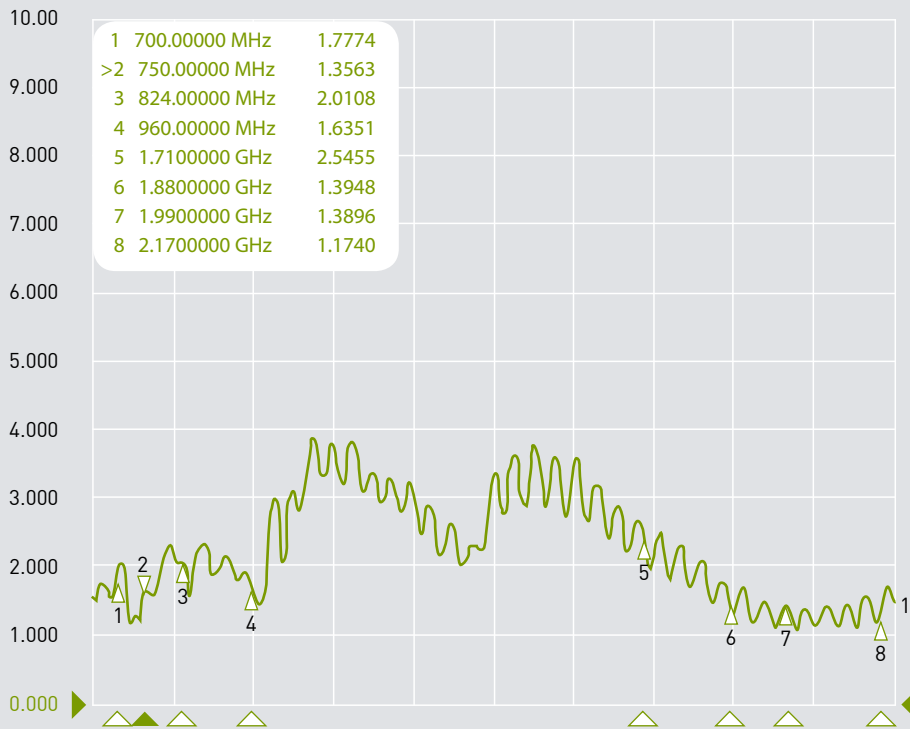

1 Start 650 MHz

IFBW 10 kHz

Stop 2.2 GHz Cor

GSM / UMTS Band VSWR (with length 3 meter CFD-200 Cable)

7. Efficiency

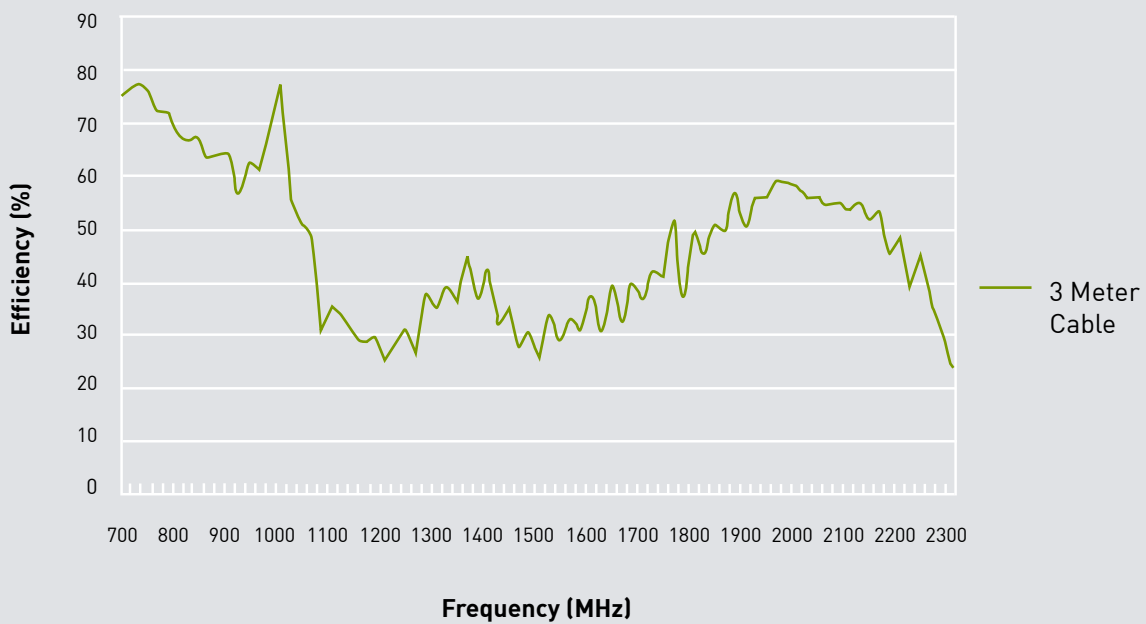

GSM / UMTS Band Efficiency (with length 3 meter CFD-200 Cable)

8. Average Gain

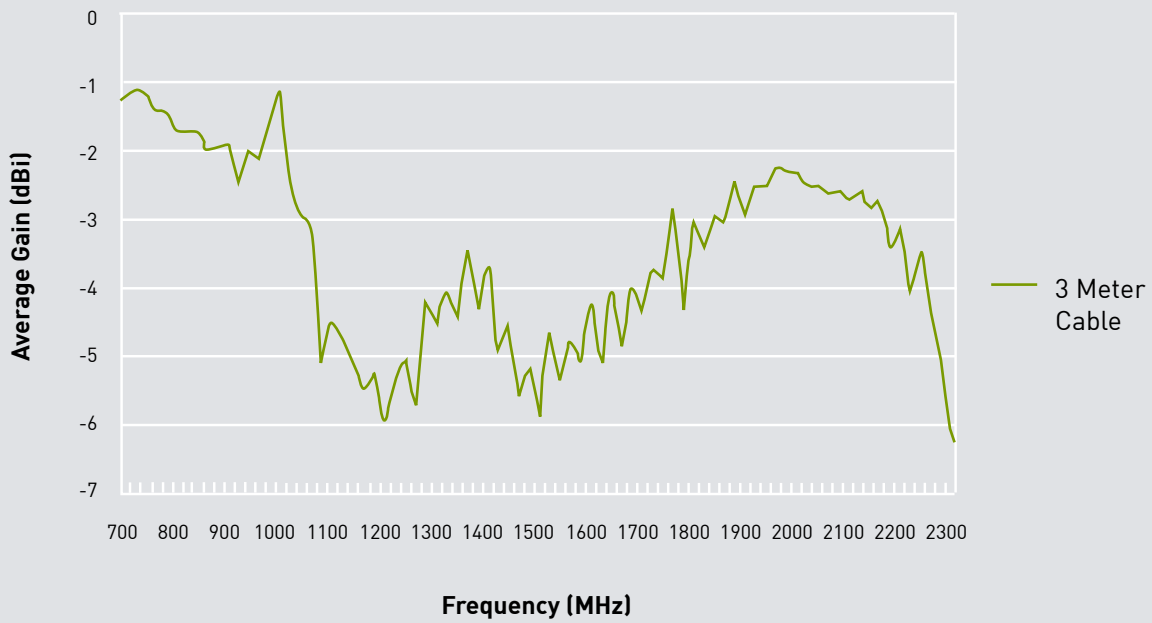

GSM / UMTS Average Gain (with length 3 meter CFD-200 Cable)

9. Peak Gain

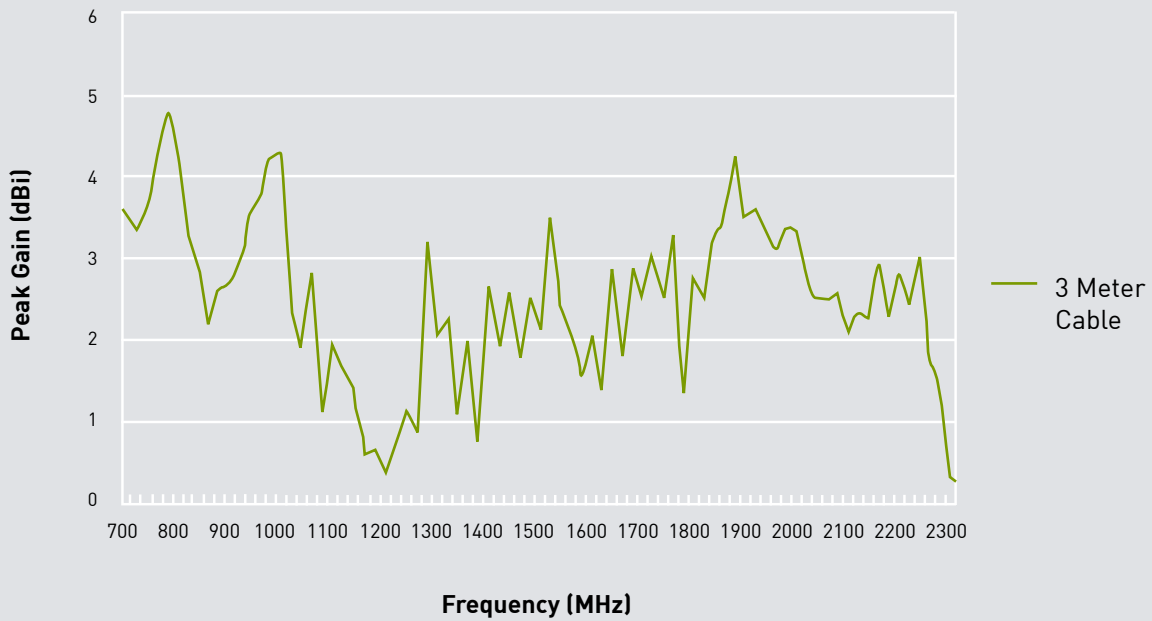

GSM / UMTS Peak Gain (with length 3 meter CFD-200 Cable)

10. LNA

Parameter

Frequency Range	1575.42+/-1.023Mhz
Output Impedance	50Ω
Output Power at 1dB Compression Point	-35dBm typ.
Output VSWR	2.0 Max.

Supply Voltage	Gain(Typ)	Noise Figure(Typ)	Power Consumption (Typ.)
1.8V	27.0dB	2.2dB	5.5mA
3.0V	32.9dB	2.3dB	12.5mA
5.5V	33.8dB	2.5dB	15.0mA

11. LNA Noise Figure at 3.0V

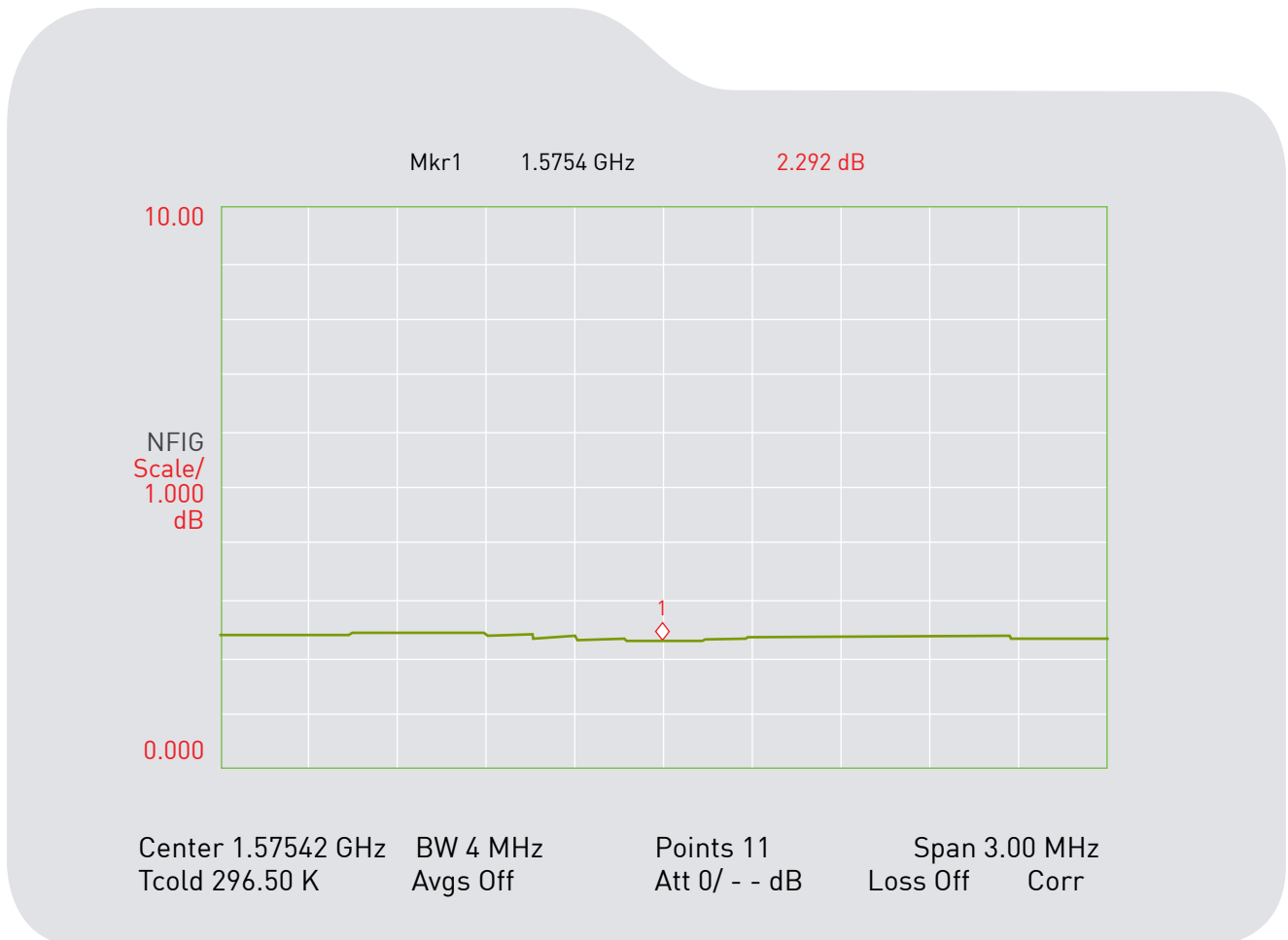

12. LNA Gain and Output of VSWR at 3.0V

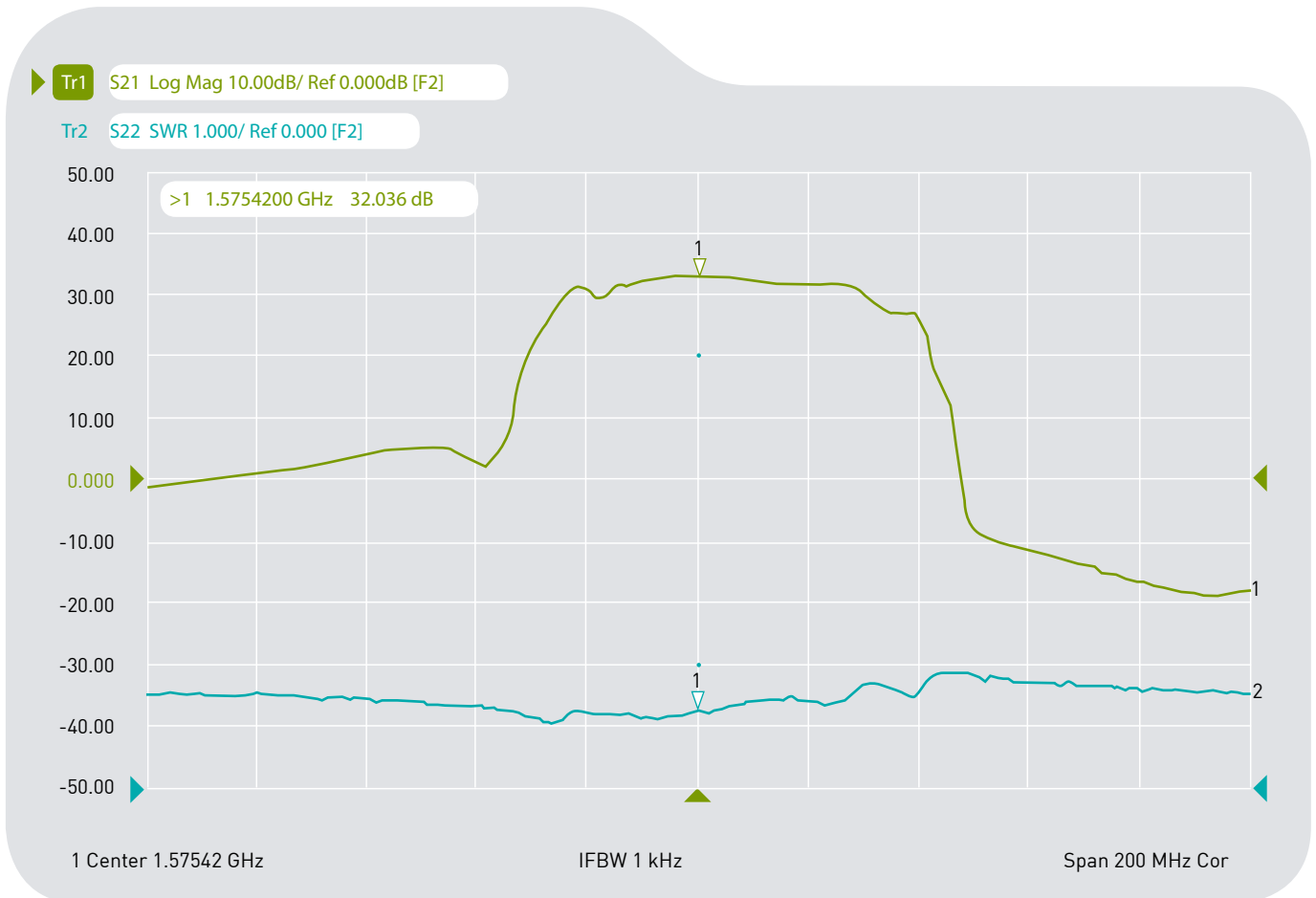

Ch1	Tr1	S21	>1	1.5754200 GHz	32.936 dB
Ch1	Tr2	S21	1	1.5754200 GHz	1.2368

13. GPS Antenna Specifications (Through Antenna, LNA and Cable Assembly)

Parameter

Frequency Range	1575.42+/-1.023Mhz
Gain at 3.0V	32.5dBic @ Zenith
Output VSWR	2.0 Max.
Output Impedance	50Ω

14. 20dB min isolation to GPS LNA input and LTE / GSM / UMTS ANTENNA

Tr1 S12 Log Mag 10.00dB/ Ref 0.000dB [F2]

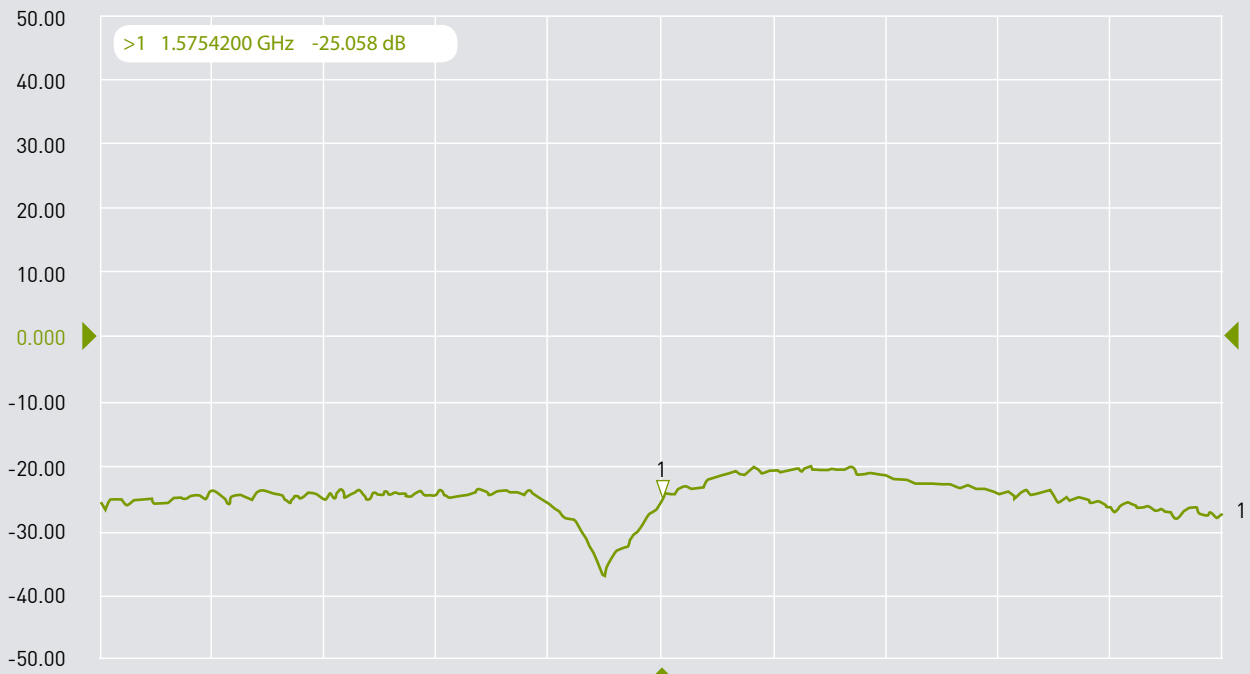

1 Center 1.57542 GHz

IFBW 1 kHz

Span 200 MHz Cor

Ch1 Tr1 S12 >1 1.5754200 GHz -25.058 dB

15. Drawing

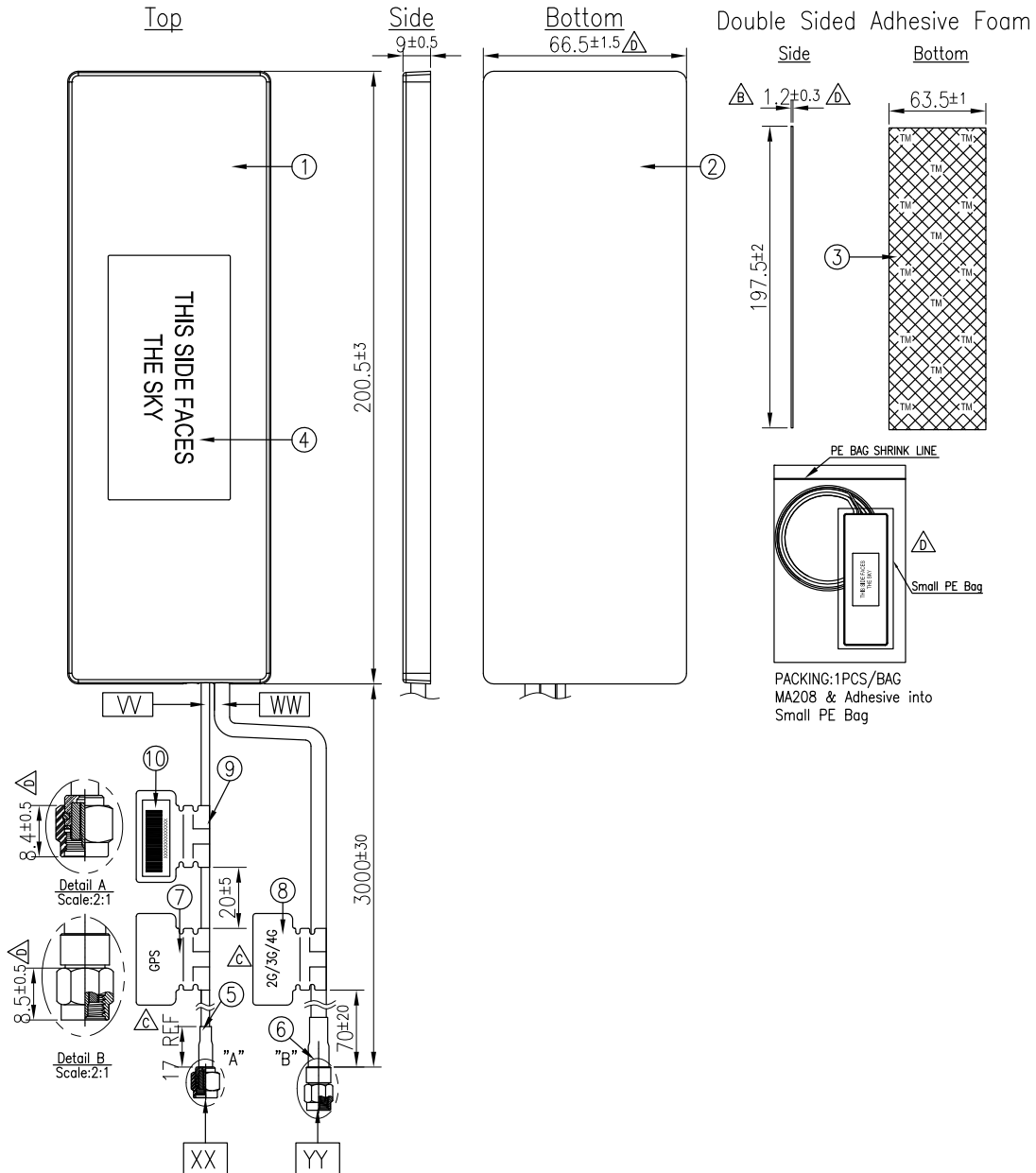

	Name	Δ P/N Δ	Material	Finish	QTY
1	Housing Top	000115L000015A	ABS	Black	1
2	Housing Bottom	000115L010015A	ABS	Black	1
3	Double Sided Adhesive Foam	001015L020015A	3M 1600SB	Green Liner	1
4	Clear Label	001016C010015A	PET	Black	1
5	Heat Shrink Tube	001315C020000A	PE	Black	1
6	Heat Shrink Tube	001315C030000A	PE	Black	1
7	GPS Label	001013B000015A	Coated Paper	Orange	1
8	2G/3G/4G Label	001014C000015A	Coated Paper	White	1
9	White Label (48x30)	001015G000000A	PET	White	1
10	Barcode Label (25x9)	001015G010000A	PET	White	1

	Name	P/N	Spec	Finish	QTY
W	Cable Type	301315C000000A	RG174	Black	1
WW	Cable Type	301415C010000A	CFD-200	Black	1
XX	Connector Type	200212G000015A	SMA(M)ST	Au Plated	1
YY	Connector Type	200212G010015A	SMA(M)ST	Au Plated	1

16. SPQ Packaging

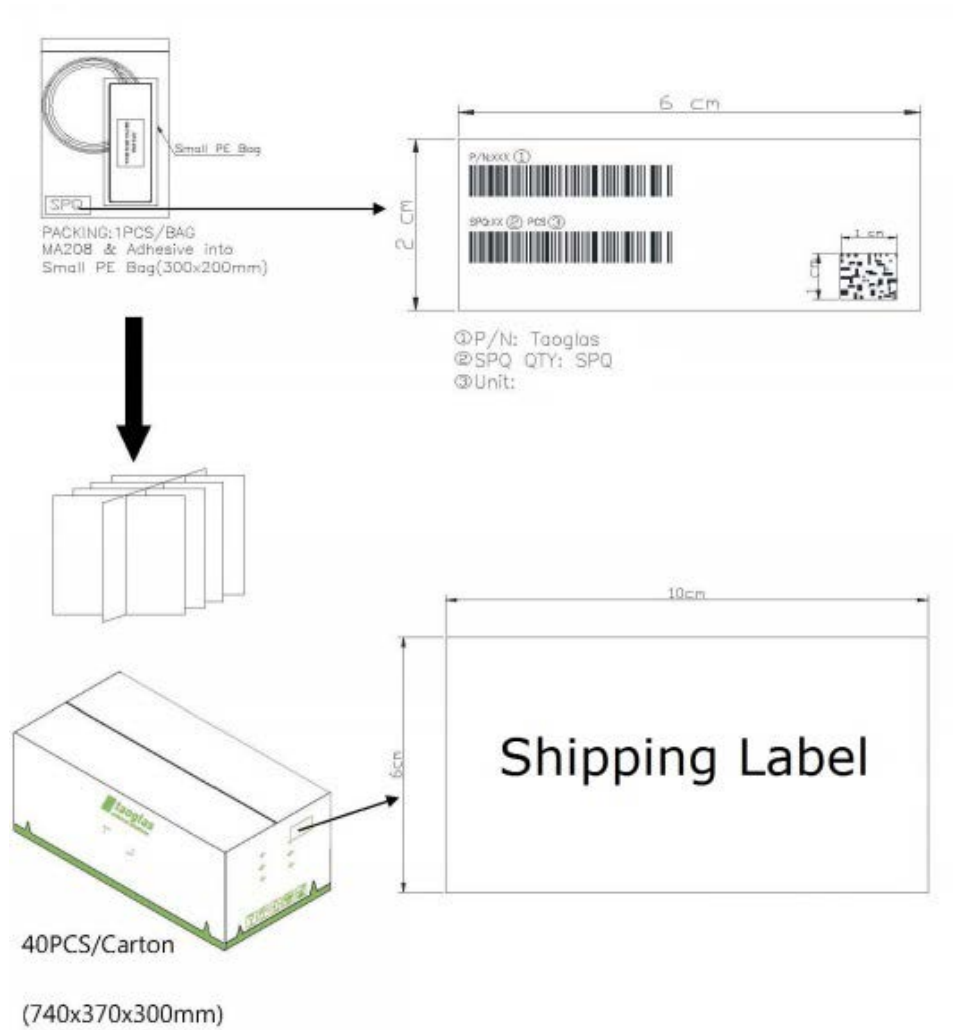

17. Packaging

2 pc MA208.A.AB.001 per carton
Carton Dimensions - 300*200mm
Total Weight - 260g

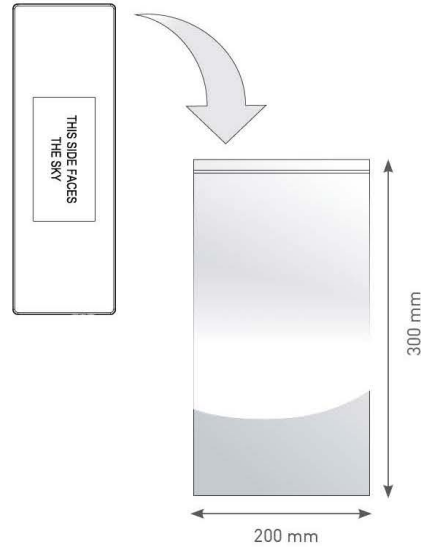

50 pcs MA208.A.AB.001 per carton
Carton Dimensions - 740*370*300mm
Total Weight - 14.4kg

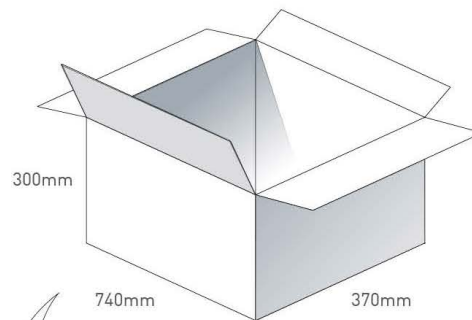

Pallet Dimensions 1200mm*1000mm*1350mm
16 Cartons per pallet
4 Cartons per layer
4 Layers

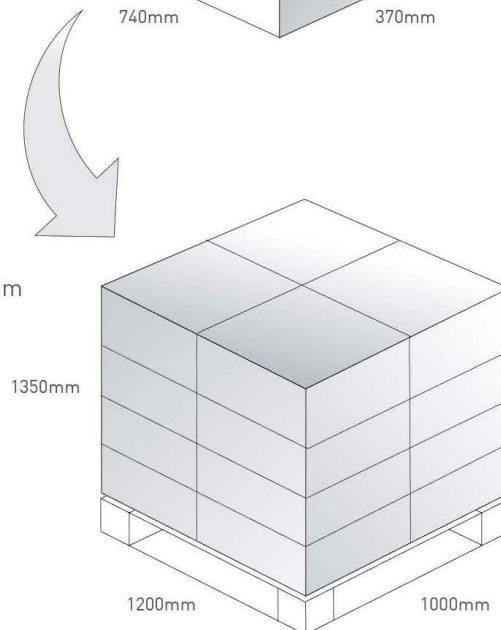

Taoglas makes no warranties based on the accuracy or completeness of the contents of this document and reserves the right to make changes to specifications and

product descriptions at any time without notice.

Taoglas reserves all rights to this document and the information

contained herein. Reproduction, use or disclosure to third parties without express permission is strictly prohibited.
Copyright © Taoglas Ltd.